

aquatherm **energy**
Guidelines —



5	Introduction ___	17	Planning ___	29	aquatherm energy - Socket ___
6	Fields of application ___	19	Pipeline route ___	30	Half-shell PUR - Hard foam ___
7	Technical data ___	20	Length changes / compensation / length expansion ___	31	Dimension change ___
8	Permissible temperature and operating pressures ___	21	Component / System overview ___	32	aquatherm energy blue/green ___
9	Permissible operating pressures for general applications ___	22	Branches in a pipeline ___	33	System features aquatherm energy ___
10	HDPE-Jacket pipes ___	23	Drainage and ventilation ___	36	List of tools ___
11	PUR-Hard foam ___	24	Shut-off devices ___		
12	Product overview: Pipe diameter ___	25	Component implementation / House entry ___		
13	Physiological and microbiological harmlessness ___	26	Connection of the aquatherm energy pipe to an existing installation ___		
14	Chemical resistance ___	27	Connecting points ___		
15	Dimensions, weight and volume ___	28	Insulating tape ___		

Introduction

The aquatherm planning guideline is addressed to planners, plant constructors and industrial customers who are looking for a solution for underground/exposed heat supply networks, industrial, cooling and refrigeration plants as well as other plants where aquatherm energy pipe systems can be used. The document contains information about the system components and guidelines for the professional planners. In case of further questions and for further information, please contact our technical service or our worldwide operating contact persons.

System description

The aquatherm energy-piping system consists of pre-insulated polypropylene pipes as well as fittings and connectors. All service pipes, fittings and connecting pieces used in aquatherm energy are made of the material fusiolen® PP-R/PP-RCT, insulated with PUR-hard foam and enclosed with a casing pipe of HDPE.

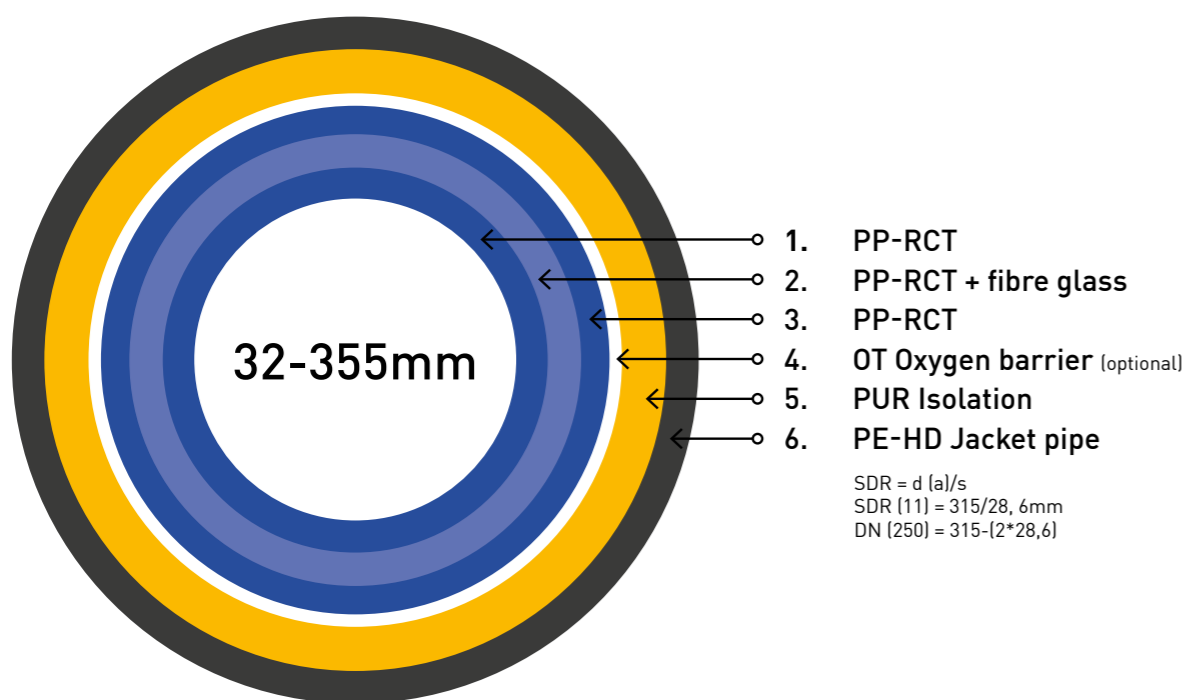

Fields of application

The pre-insulated aquatherm energy pipe is primarily suitable for the energy-efficient transport of heating and cooling media. The system is the solution for many different applications to distribute heat and cold. Here are some possible applications: district heating supply, local heating supply, district cooling supply, water distribution, cooling plants, biomass plants, biogas plants, geothermal energy, geothermal heat, swimming pool technology, open space heating, open space cooling, thermal water pipes - cooling technology - connection to heat pumps - lawn heating air conditioning systems.

Our customers and partners appreciate aquatherm energy:

Agility

The medium pipes used in the aquatherm energy are convincing due to the simple, material-locking and highly stable connection technology by means of plastic welding.

Flexibility

aquatherm pipes can be cut and shortened quickly and easily

Custom made

If moulded parts other than those available in the catalogue are required, these will be specially produced in the factory according to the customer's drawing.

Your costs are reduced by:

- Minimised trench size compared to steel pipes
- No expansion bends necessary
- Low weight approx. 70 % lighter than steel
- Short processing times approx. 50 % less working time than with steel pipes
- Corrosion resistance from the outside and inside
- Incrustation resistance, less pressure drop due to pipe roughness
- Cost-effective assembly

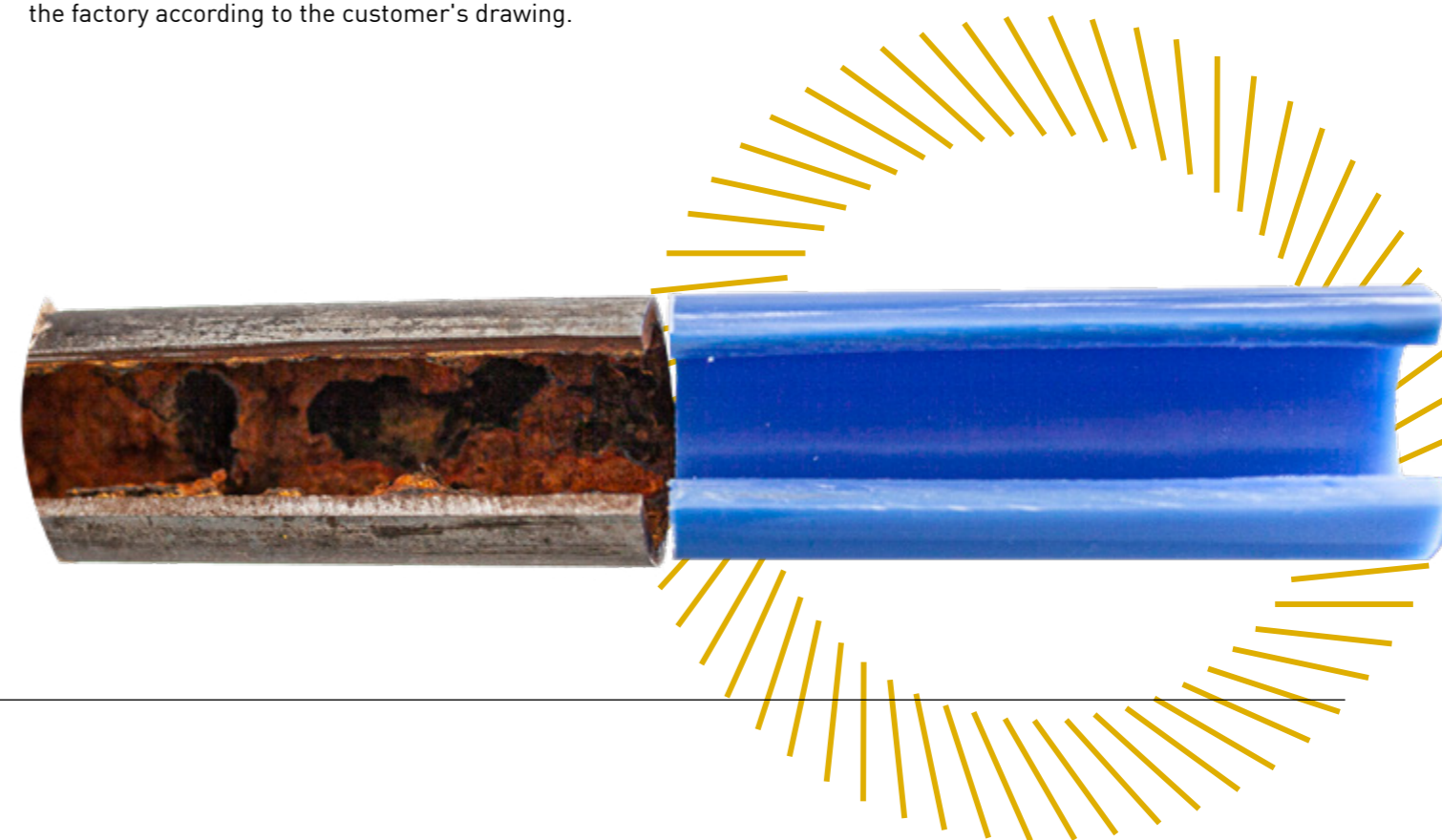

Technical data

Medium pipes PP-R

The service pipes used in the pre-insulated aquatherm energy pipe systems are manufactured as fibre composite pipes made of polypropylene.

aquatherm energy green SDR 9 MF RP

This piping system made of fusiolen® PP-RCT and a special fibre filling, which is introduced as a middle layer in the PP-RCT material, is particularly suitable for the installation of drinking water pipe networks.

aquatherm energy blue SDR 11 MF RP / 17,6 MF RP

The aquatherm blue pipe system has been specially developed for applications outside the drinking water installation. In addition to the general advantages of a PP-RCT pipe system, aquatherm blue offers larger flow rates due to smaller pipe wall thicknesses compared to the aquatherm green system.

aquatherm energy blue SDR 11 MF RP OT

With the newly developed aquatherm blue SDR 11 MF RP OT energy, aquatherm offers an oxygen-tight multi-layer plastic composite pipe, which is equipped with a diffusion barrier and therefore meets the requirements of DIN 4726.

The aquatherm blue fibre composite pipe OT, in combination with the aquatherm green pipe system, contains all components for the pipe installation of air conditioning and heating systems as well as for the system technology.

Permissible temperature and operating pressures

The physical and chemical properties of the system are adapted to the special concerns of the requirements. The extrapolated service life of aquatherm PP-R/PP-RCT pipes is more than 50 years. Peak temperatures of 100°C due to short-term disturbances are unproblematic. At continuous temperatures of > 70 °C to 90 °C the service life of the pipe is reduced. See table "Permissible operating pressures".

Lifetime >50 Years*

Peak temperatures up to 100°C*

Permanent temperatures up to 70-90°C

* Please observe the currently valid table "Permissible operating pressures" at the time of installation.

Material parameters

Technical data		PP-MF
Melt index 230°C/2,16 kg	0,3g / 10 min	
Density	1,0 g / cm ³	
Elasticity modulus		1200 N / mm ²
Yield stress	30 N / mm ²	
Tensile strength		35 MPa
Thermal conductivity coefficient	0,15 W / mK	
Pipe roughness		0,007 mm
Average therm. Linear exp. -Coeff.	0,035 mm / mK	

All aquatherm polypropylene pipes have a ring stiffness of $\geq 16\text{kN/m}^2$ (acc. to DIN EN ISO 9969) and can therefore be classified in ring stiffness class SN16.



Permissible operating pressures for general applications

Years of operation	aquatherm blue SDR 17,6 MF RP	aquatherm blue SDR 11 MF RP	aquatherm blue SDR 11 S	aquatherm blue SDR 9 MF RP	aquatherm green SDR 7,4 MF	aquatherm green SDR 9 MF RP
At a temperature of up to 10 °C						
10	13,1 bar	25,3 bar	19,3 bar	27,5 bar	27,7 bar	27,5 bar
25	12,9 bar	24,7 bar	18,7 bar	27,1 bar	26,9 bar	27,1 bar
50	12,7 bar	24,1 bar	18,2 bar	26,7 bar	26,1 bar	26,7 bar
100	12,6 bar	23,5 bar	17,8 bar	26,3 bar	25,2 bar	26,3 bar
At a temperature of up to 15 °C						
10	12,3 bar	23,4 bar	17,8 bar	25,7 bar	26,9 bar	25,7 bar
25	12,1 bar	22,8 bar	17,2 bar	25,2 bar	26,1 bar	25,2 bar
50	11,9 bar	22,2 bar	16,8 bar	24,9 bar	25,3 bar	24,9 bar
100	11,7 bar	21,6 bar	16,3 bar	24,5 bar	24,5 bar	24,5 bar
At a temperature of up to 20 °C						
10	11,4 bar	21,4 bar	16,4 bar	23,9 bar	26,1 bar	23,9 bar
25	11,2 bar	21,0 bar	15,9 bar	23,5 bar	25,3 bar	23,5 bar
50	11,0 bar	20,4 bar	15,4 bar	23,1 bar	24,5 bar	23,1 bar
100	10,9 bar	19,9 bar	15,0 bar	22,8 bar	23,7 bar	22,8 bar
At a temperature of up to 30 °C						
10	9,8 bar	18,3 bar	13,9 bar	20,6 bar	22,0 bar	20,6 bar
25	9,6 bar	17,8 bar	13,4 bar	20,2 bar	21,3 bar	20,2 bar
50	9,5 bar	17,3 bar	13,0 bar	19,9 bar	20,7 bar	19,9 bar
100	9,4 bar	16,8 bar	12,7 bar	19,7 bar	20,0 bar	19,7 bar
At a temperature of up to 40 °C						
10	8,4 bar	15,5 bar	11,8 bar	17,7 bar	18,7 bar	17,7 bar
25	8,3 bar	15,0 bar	11,3 bar	17,3 bar	18,0 bar	17,3 bar
50	8,1 bar	14,6 bar	11,0 bar	17,1 bar	17,5 bar	17,1 bar
100	8,0 bar	14,1 bar	10,7 bar	16,8 bar	16,8 bar	16,8 bar
At a temperature of up to 50 °C						
10	7,2 bar	13,0 bar	9,9 bar	15,1 bar	15,7 bar	15,1 bar
25	7,0 bar	12,6 bar	9,5 bar	14,7 bar	15,2 bar	14,7 bar
50	6,9 bar	12,2 bar	9,2 bar	14,5 bar	14,7 bar	14,5 bar
100	6,8 bar	11,9 bar	9,0 bar	14,3 bar	14,1 bar	14,3 bar
At a temperature of up to 60 °C						
10	6,1 bar	10,9 bar	8,3 bar	12,7 bar	13,2 bar	12,7 bar
25	5,9 bar	10,6 bar	8,0 bar	12,4 bar	12,6 bar	12,4 bar
50	5,8 bar	10,3 bar	7,7 bar	12,2 bar	12,1 bar	12,2 bar
At a temperature of up to 70 °C						
10	5,1 bar	8,5 bar	7,0 bar	10,7 bar	11,1 bar	10,7 bar
25	5,0 bar	8,3 bar	6,0 bar	10,4 bar	9,6 bar	10,4 bar
50	4,9 bar	8,1 bar	5,1 bar	10,2 bar	8,1 bar	10,2 bar
At a temperature of up to 75 °C						
10	4,6 bar	7,7 bar	6,0 bar	9,7 bar	10,0 bar	9,7 bar
25	4,5 bar	7,6 bar	4,8 bar	9,5 bar	8,0 bar	9,5 bar
50	4,4 bar	7,3 bar	4,0 bar	9,3 bar	6,7 bar	9,3 bar
At a temperature of up to 80 °C						
5	4,3 bar	7,2 bar	5,7 bar	9,0 bar	9,2 bar	9,0 bar
10	4,2 bar	7,0 bar	4,8 bar	8,9 bar	7,8 bar	8,9 bar
25	4,1 bar	6,8 bar	3,9 bar	8,6 bar	6,2 bar	8,6 bar
At a temperature of up to 90 °C						
5	3,5 bar	5,9 bar	3,7 bar	7,4 bar	6,0 bar	7,4 bar
10	3,4 bar	5,8 bar	3,2 bar	7,3 bar	5,1 bar	7,3 bar

For fittings made of butt-welded pipe segments, a weakening coefficient of 0.75 applies (reduction of the table values by 25 %).

HDPE-Jacket pipes

aquatherm energy pipe systems are coated with HDPE pipes. The quality meets the highest requirements, as this part of the pipe is exposed to the most wear during transport or installation. The casing pipes are suitable for the typical district heating applications as described in the above mentioned standards.

HDPE-class	PE 80
Density, g/cm ³	0,95
Average them. Length exp. - Coeff.	1,8x10 ⁻⁴
Yield stress	22 MPa
Temperature application range	- 40 do 80°C
Modulus of elasticity	800 MPa
UV radiation	Resistant due to 2-3% carbon black
FNCT-test	≥300h

Jacket pipes correspond:

DIN EN 8075 in accordance with which pipes are manufactured from HDPE meet the technical functional requirements of DIN EN 253 *.



*EN253, TABLE 5 FOR NOMINAL DIAMETER AND MINIMAL WALL THICKNESS
EN253, TABLE 6 FOR MAXIMUM AND MINIMUM OUTSIDE DIAMETER OF THE ASSEMBLY

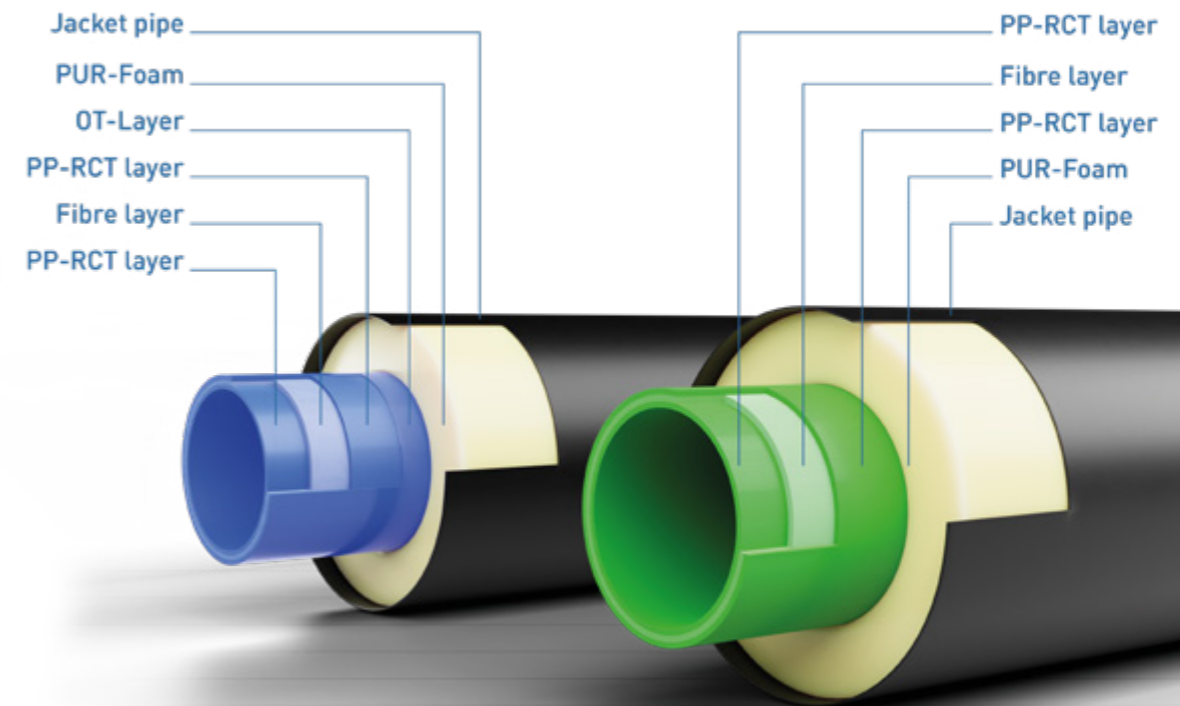

PUR-Hard foam

aquatherm energy pipe systems are insulated with PUR rigid foam. aquatherm energy belongs to the rigid pipe systems which are processed with different components (pipes and fittings) to a complete system. As with all pre-insulated systems, it consists of pre-insulated rod pipe as well as pre-insulated fittings and connectors.

For the professional and proper sheathing of joints at pipes and fittings, insulating shells made of PUR-hard foam are available for the aquatherm energy pipe systems. These are wrapped with shrink sleeves and result in an inseparable connection to the casing pipes. If required, joints can also be foamed locally.

Polyurethane foam is made from polyol and isocyanate and meets the functional requirements of DIN EN 253.

The foam is homogeneous with an average cell size of maximum 0.5 mm.

Technical data	PUR
Compressive strength 10 % deformation	> 0,3 N/mm ²
Closed cell	> 88 %
Core density	> 60 kg/m ³
Shear strength	> 0,12 N/mm ²
Tangential shear strength	> 0,20 N/mm ²
Water absorption	< 10 % (Vol)
Thermal conductivity at 50 °C	0,027 W/mK
Cyclopentane cell gas	> 8 %

Product overview: Pipe diameter

aquatherm energy green & blue

Diameter in mm	16	17	20	25	32	40	50	63	75	90	110	125	160	200	250	315	355	400	450	500	630	
SDR 9 MFRP	•	•	•	•	●	●	●	●	●	●	●	●	●	●	●	●	•	•	•	•	•	•
SDR 9 MFRPOT	•	•	•	•	●	•	•	•	•	•	•	•	•	•	•	•	•	•	•	•	•	•
SDR 11 MFRP	•	•	•	•	•	●	●	●	●	●	●	●	●	●	●	●	●	•	•	•	•	•
SDR 11 MFRPOT	•	•	•	•	•	●	●	●	●	●	●	●	●	●	●	●	•	•	•	•	•	•
SDR 17,6 MFRP	•	•	•	•	•	•	•	•	•	•	•	•	●	●	●	●	●	•	•	•	•	•

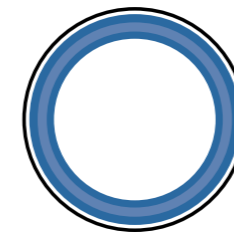

SDR 9

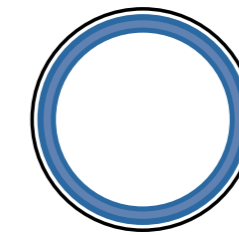

SDR 11

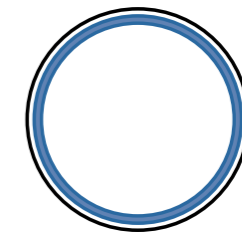

SDR 17,6

Physiological and microbiological harmlessness

All system components that come into contact with the drinking water as intended are certified by external hygiene institutes and comply with the requirements of DIN EN 806 as well as national and international standards. The following standards refer to Germany DIN EN 806 DIN 1988 T 2.

KTW-recommendations of the "BfR" (Federal Institute for Risk Assessment) DVGW worksheet W 270. The aquatherm energy system components are joined by welding (fusion). No additional materials are required which could influence the physiological harmlessness of the system.



Chemical resistance

aquatherm green/blue pipes and fittings are characterised by a particularly high chemical resistance. The chemical resistance of polypropylene depends on the medium and its concentration as well as other factors such as medium temperature, pressure and ambient temperature.

aquatherm green connection elements with threaded inserts made of brass are not suitable for all media. Especially in industrial applications of aquatherm green and aquatherm blue pipes. We therefore recommend the use of aquatherm green flanges with flanged bushings and/or coupling fittings made of polypropylene.

Notice:

On request, threaded inserts for aquatherm green connection parts are also available in stainless steel.

If a fluid other than water is to be passed through the service pipe, please be sure to contact our technical department (technical.support@aquatherm.de) in advance to rule out any possible risks.



Dimensions, weight and volume

aquatherm energy blue

SDR 9 MF RP energy / SDR 9 MF RP OT energy
SDR 11 MF RP energy / SDR 11 MF RP OT energy

Trade name: aquatherm energy blue/green, aquatherm energy blue OT
Manufacturer: aquatherm GmbH
Material: PP-RCT/ PP-RCT-GF/ PP-RCT – PUR – HDPE80
Pipe series: SDR 9/11

Medium pipe PP-R	Jacket pipe HDPE	aquatherm energy blue *SDR 9 MF RP / OT SDR 11 MF RP / OT		PUR	Outer diameter of medium pipe	Wall thickness	Inner diameter	Nominal width
Outer diameter mm		Weight	Volume content	Thickness	Medium pipe			
		kg/m	l/m	mm	mm	mm	mm	DN
32*	90	1,52	0,483	26,00	32	3,6	26,2	25
40	110	2,00	0,834	32,00	40	3,7	32,6	32
50	110	2,20	1,307	27,00	50	4,6	40,8	40
63	125	2,80	2,074	28,00	63	5,8	51,4	50
75	140	3,50	2,959	29,50	75	6,8	61,4	65
90	160	4,50	4,525	32,00	90	8,2	73,6	80
110	200	6,50	6,359	41,80	110	10,0	90,0	80/100
125	225	8,20	8,199	46,50	125	11,4	102,2	100
160	250	11,40	13,430	41,10	160	14,6	130,8	125
200	315	17,90	21,010	52,60	200	18,2	163,6	150
250	400	28,50	32,861	68,70	250	22,7	204,6	200
315**	450	40,00	52,172	60,50	315	28,6	257,8	250
355**	500	54,90	66,290	56,90	355	32,2	290,6	300

** without OT Layer

aquatherm energy blue

SDR 17,6 MF RP energy

Trade name: aquatherm energy blue
Manufacturer: aquatherm GmbH
Material: PP-RCT/ PP-RCT-GF/ PP-RCT – PUR – PE80
Pipe series: SDR 17,6

Medium pipe PP-R	Jacket pipe HDPE	aquatherm energy blue SDR 17,6		PUR	Outer diameter of medium pipe	Wall thickness	Inner diameter	Nominal width
Outer diameter mm		Weight	Volume content	Thickness	Medium pipe			
		kg/m	l/m	mm	mm	mm	mm	DN
125	225	6,80	9,64	46,50	125	7,1	102,2	100
160	250	9,03	15,79	41,10	160	9,1	141,8	150
200	315	14,22	24,66	52,60	200	11,4	177,2	200
250	400	22,77	38,57	68,70	250	14,2	221,6	250
315	450	31,04	61,22	60,50	315	17,9	279,2	300
355	500	47,50	77,83	56,90	355	20,1	314,8	350

aquatherm energy green

SDR 9 MF RP energy

Trade name: aquatherm energy green
Manufacturer: aquatherm GmbH
Material: PP-RCT/ PP-RCT-GF/ PP-RCT – PUR – HDPE80
Pipe series: SDR 9

Medium pipe PP-R	Jacket pipe HDPE	aquatherm energy green SDR 9		PUR	Outer diameter of medium pipe	Wall thickness	Inner diameter	Nominal width
Outer diameter mm		Weight	Volume content	Thickness	Medium pipe			
		kg/m	l/m	mm	mm	mm	mm	DN
32	90	1,43	0,483	26,00	32	3,6	24,8	25
40	110	1,97	0,754	32,00	40	4,5	31,0	32
50	110	2,15	1,182	27,00	50	5,6	38,8	40
63	125	2,73	1,869	28,00	63	7,1	48,8	50
75	140	3,51	2,659	29,50	75	8,4	58,2	60
90	160	4,55	3,825	32,00	90	10,1	69,8	65
110	200	6,50	5,725	41,80	110	12,3	85,4	80
125	225	8,34	7,386	46,50	125	14,0	97,0	100
160	250	11,77	12,109	41,10	160	17,9	124,2	125
200	315	18,80	18,908	52,60	200	22,4	155,2	150
250	400	29,53	29,605	68,70	250	27,9	194,2	200
315	450	57,40	46,966	60,50	315	35,2	244,6	250

Planning

Space requirement in the trench

In the case of buried pipeline routes, the proper condition of the trenches must be checked before installation work begins.

The excavated material resulting from the excavation work must be deposited in such a way that it does not hinder the installation work.

In order to ensure a professional and proper installation of the aquatherm energy joints in the trench, sufficient working space must be available around the application points. The bottom of the trench must be free of water and mud. The pipe laying and the pipe support must comply with the requirements.

Civil engineering guidelines and dimensions

Earthworks are to be carried out in accordance with the general guidelines and standards for civil engineering works. Pipe trenches shall be constructed by competent personnel in accordance with DIN 18300, DIN EN 805, DIN 4124 and backfilled in accordance with sections 3.09 and 3.11 of DIN 18300. DIN 4124 also specifies whether pipe trenches must be embanked or obstructed.

The guidelines in DIN EN 1610, Condition of the trench bottom, must be observed.

- The total length of the invert must be load-bearing and free of stones.
- The pipe-layer is responsible for ensuring quality until completion. This includes drainage and keeping the pipe trenches free.

Safety and accident prevention

The activities in pits and trenches described in the accident prevention regulation "Bauarbeiten BGV C 22" are binding.

§28 (1) During earthworks, rock excavations, earth and rock walls shall be sloped or built up in such a way that workers cannot be endangered by slipping masses. All influences that may affect the stability of the ground shall be taken into account.

§32 Working space widths

Excavation pits and pipe trenches in which work is carried out must have sufficient working space. The dimensions of the working space depend on the slope angle, shoring, type of pipe and work sequence.

HDPE-Outer pipe D (mm)	Trench width B (m)	Pipe spacing s (m)
90	0,63	0,15
110	0,67	0,15
125	0,70	0,15
140	0,73	0,15
160	0,92	0,20
200	1,00	0,20
225	1,05	0,25
250	1,40	0,30
315	1,53	0,40
400	2,00	0,45
450	2,40	0,50
500	2,50	0,55

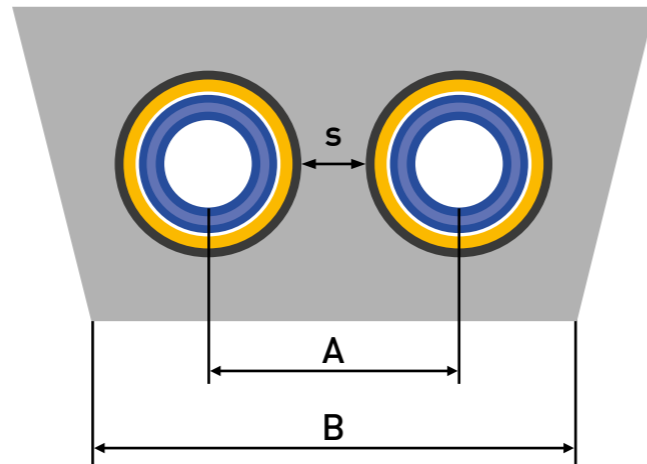

Buried

The trench depth is the sum of the depth of the frost line, the outer diameter of the pipe and the height of the bedding (A + Da + B). The frost limits must be observed; 0.5-9.0 m above the top of the pipe (E). If the pipes are installed outside the specified installation depths, load distribution by steel or concrete plates must be installed.

Traffic loads

SLW 60, heavy duty forklift (60 t maximum load). SN classification = SN16 KN according to ISO 9969. Recommended calculation according to ATV A 127 (basis for calculation). We recommend laying the pipes in a narrow trench where there is nevertheless sufficient working space.

Bedding layer (B)

For normal soil, 100 mm sand with round grain size 0-8 mm.

For rock or rock-like soils, 150 mm sand with round grain size 0-8 mm.

This layer is compacted evenly ($\geq 97\%$ Proctor) with recesses in the socket area. Non-load-bearing soils are made load-bearing through the selection of the bedding layer. Observe planning specifications.

Backfilling

The 4/8 mm granulation material is placed in layers to create the side backfill (C) and the cover (D). The pipe crown (E) is covered with min. 100 mm. Afterwards, the main backfilling (F) can be carried out with the excavation.

It must be ensured that the grain size does not exceed 300 mm and that sharp and coarse stones are removed. Planning specifications of the backfill stages must always be observed. Each backfill is compacted individually.

Compression

Compaction ($\geq 97\%$ Proctor) of the side backfill (C) and cover (D) is done by hand or with light equipment. When the main backfill has been placed with min. 20 cm, the trench can be compacted with 95 % Proctor from this layer upwards using heavy equipment. The last 50 cm of the trench are compacted with 97-100 % Proctor.

Covering

The overlap should be at least 0.8 m, measured from the top of the energy pipe to the ground level (Fig. 2) or 0.4 m to the road foundation (Fig. 3). In the systems in which the jump-over branches are installed, the above-mentioned widths should be measured from the top of the branches.

In the case where the required covering layer cannot be applied, a reinforced concrete slab can be placed over the pipes.

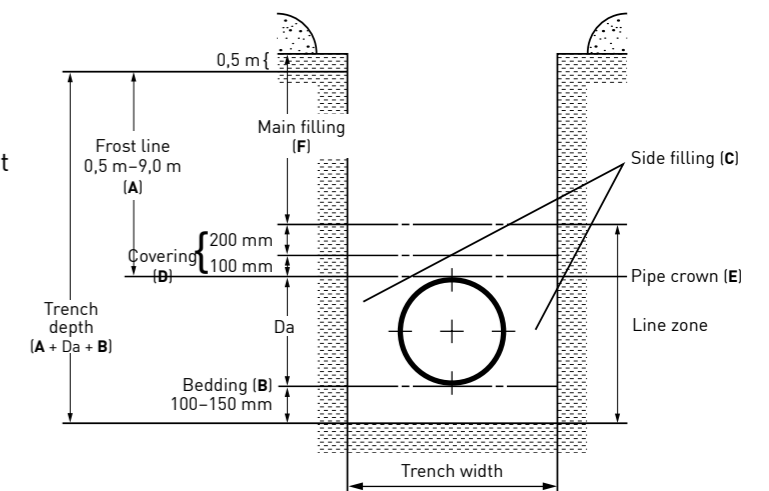

Pipeline route

The carrier pipes used with aquatherm energy are also convincing due to the simple but effective installation and connection technique. By heating the pipe end and the connecting part, the plastic melts into an inseparable connection after joining the elements. aquatherm blue fibre composite OT pipes up to 125 mm have to be prepared with the peeling tools art.-No. 9800050479-9800050488 before processing.

(Diameter 32-125 mm, or butt-welded diameter 160-315 mm).

The aquatherm energy pipes can be cut and shortened as desired (Important: The length of the free pipe end for making a connection must be maintained).

Shaped parts must not be shortened. If shorter moulded parts are required, these are specially made in the factory according to the customer's drawing.

Joints must be pre-insulated with the aquatherm energy post-insulation sleeve set - insulation sleeve consisting of shrink sleeve with PUR rigid foam elements and accessories in a total length of 600 mm.

The adjustment of the pipeline route is mainly carried out by means of the bends (45° or 90°). The pre-insulated bends are available in 45° and 90° versions (other degrees on request). They enable changes to be made to the route in the vertical and horizontal directions.

Medium pipe		Jacket pipe	Bending radius r [m]	Bending angle γ [°]	
Outer diameter [mm]	Nominal width [mm]	Outer diameter [mm]		Bar l= 5,8m	Bar l= 11,6m
32	DN 25	90	4,2	79	158
40	DN 32	110	4,4	76	151
50	DN 40	110	5	66	133
63	DN 50	125	6,3	53	105
75	DN 65	140	7,5	44	89
90	DN 65 / DN 80	160	9	37	74
110	DN 80 / DN 100	200	11	30	60
125	DN 100	225	12,5	27	53
160	DN 125 / DN 150	250	16	21	42
200	DN 150 / DN 200	315	20	17	33
250	DN 200 / DN 250	400	25	13	27
315	DN 250 / DN 300	450	31,5	11	21
355	DN 300 / DN 350	500	39,5	9	18

Values apply for 20 °C

Length changes / compensation / length expansion

Composite pipe systems laid in the ground can be regarded as firmly embedded. At compensation points such as building entrances, frictional forces due to linear expansion caused by heat cannot be completely excluded. Branches of any kind must be dimensioned and designed in such a way that the connection points on the main pipe are not subjected to insufficient stress (mechanical stress). Composite pipe systems consisting of plastic medium pipes are self-compensating and can be laid without expansion compensation. According to AGFW FW420 Part 5, pipe static proof is not required.

This property of the pre-insulated aquatherm pipes allows the installation of straight pipes in any length. Furthermore, thanks to the very low modulus of elasticity of the carrier pipe made of PP-R/PP-RCT, the linear expansion is very low. The pipe therefore does not require any soft foam elements as expansion compensation in the bend area.

Proper operation of the buried aquatherm pipeline requires the construction of the bedding, side filling and covering of sand as well as the laying of the pipeline above the groundwater level.

The expansion of pipelines depends on the difference between the operating temperature and the installation temperature:

$DT = T\text{-operating temperature} - T\text{-assembly temperature}$

The coefficient of longitudinal expansion of aquatherm composite pipes is: aquatherm green/blue MF = 0,035 mm/mK.

Freely laid aquatherm PP-R-/PP-RCT-fibre composite pipes must be allowed to expand.

In most cases, changes in direction - bending legs - in the pipe run can be used to record the change in length. In addition to the mathematical determination, the bending leg length can be taken from the tables and diagrams.

[Linear expansion calculator](#)

Comparison PP to steel

Self-compensating Pipe system for underground installation AGFW:

aquatherm energy pipes are self-compensating, i.e. they can generally be installed without special measures to compensate for temperature-related changes in length. An atubar static proof is not required.

Plastics have a greater linear expansion than steel, but have a lower one modulus of elasticity, so that only low stresses develop in the polymer medium pipes. The changes in length are of the same magnitude as in restrained composite systems and can be significantly reduced by embedding the line in the ground. The manufacturer's instructions must be observed.

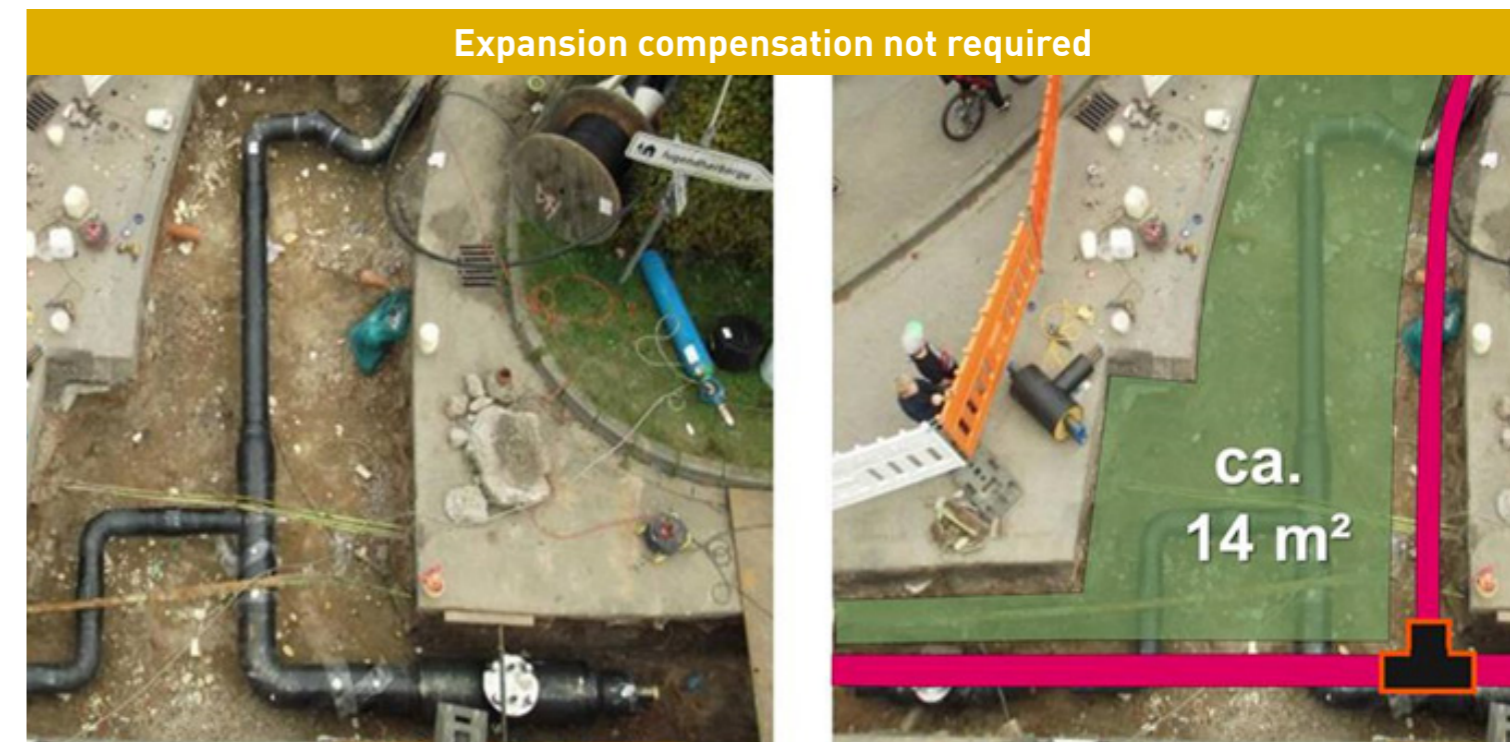



Components / System overview

The following system components are available for all aquatherm energy pipe systems:

- Tubes (rods in 5.8 m and 11.6 m lengths)
- Bends 45° and 90° (other degrees available on request)
- T-Branches
- Reducing branches
- Skip branches
- Reduce-over-jump branches
- Energy sockets
- Energy reducing-sockets
- Energy end cuff
- Special moulded parts available on request
- Annular space seals
- Socket joints for jacket pipes

Detailed descriptions of the elements can be found in the data sheet on the next pages.

Branches in a pipeline

An aquatherm energy branch can be carried out by means of the pre-insulated T-branch and jump-over branches. Parallel branches are not part of the aquatherm standard programme. Parallel branches are special components and available on request.

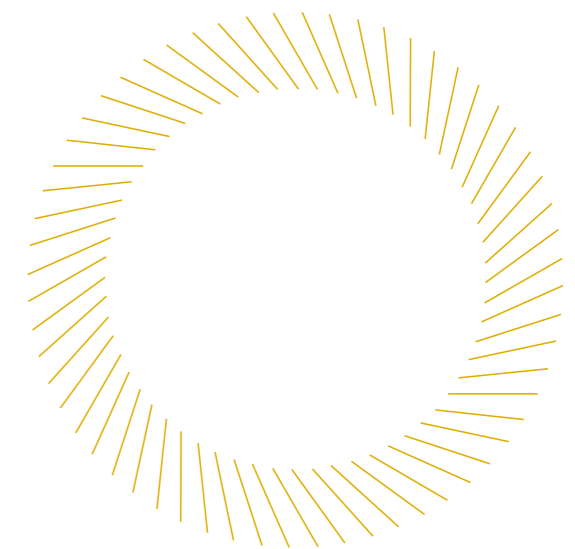

Drainage and ventilation

Drainage branch and/or venting branch can be manufactured on site by means of a pre-insulated reducer branch or a reducer junction branch, an aquatherm all-plastic ball valve and a threaded transition - with female or male thread, as required - and integrated into the route. Venting and drain valves should have a drain device for the medium to be drained (observe the composition of the medium).

The PUR foam of the vent/drain branches must be protected against moisture and contamination with an end sleeve. Make sure that the sleeve is pushed onto the branch before it is welded to the valve.

SDR	Art. no. Transition piece	Dimension mm/" AG	Outer diameter Main pipe	Outer diameter Drainage	Outer diameter Venting
	1070020028	20x3/4"	32	20	20
	1070025030	25x3/4"	40	20	20
	1070032031	32x1"	50	20	20
	1070032032	32x1 1/4"	65	25	25
6	1070040033	40x1"	75	25	25
	1070040034	40x1 1/4"	90	32	32
7,4	1070050035	50x1 1/4"	110	32	32
	1070050036	50x1 1/2"	125	32	32
9	1070063037	63x1 1/2"	160	40	32
	1070063038	63x2"	200	50	32
	1070075039	75x2"	250	50	32
	1070075040	75x2 1/2"	315	50	32
11	1070090041	90x3"	355	50	32

Table 8. Drainage and venting - recommended dimensions

Shut-off devices

No pre-insulated shut-off valves are offered by aquatherm. Shut-off valves should be installed and insulated by the customer, this installation is mostly done by shaft installation. The aquatherm energy-free pipe ends should be protected against moisture and dirt with a closing sleeve.

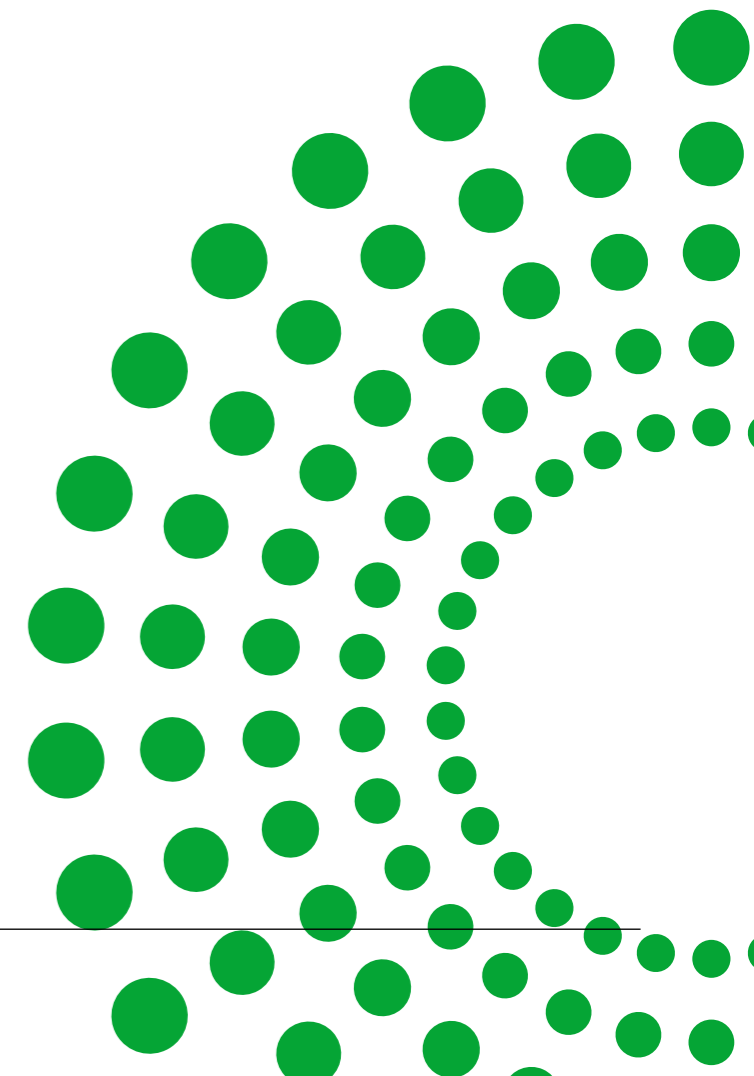
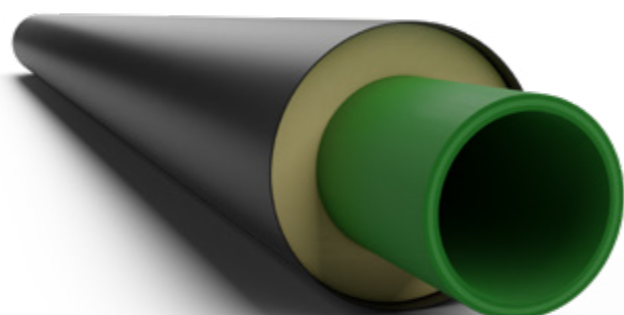



Component implementation/ House entry

Annular space seals are the safest variant for annular space sealing of wall penetrations in pipelines. The aquatherm energy pipe ends can be protected with an end seal after a wall penetration/building penetration. For entries into rooms with a permanent high humidity, it is mandatory to use closing collars to protect the PUR rigid foam against humidity and moisture. Make sure that the collar is pushed onto the pipe before the aquatherm energy-pipe is welded to the continuing pipe (see picture below).

With aquatherm energy you have the choice between different flexible solutions for the production of house connections:

- Connection with PP using a pre-insulated T-piece from the main line to a smaller PP pipe into the house or building.

- Connection with PP by saddle welding on the main pipe in combination with a reduction to a smaller PP pipe into the house or building. After welding the PP parts, the T is insulated with an open HDPE T-sleeve and filled with PUR foam.

- Drilling by means of saddle welding on the main pipe, combined with a reduction to a smaller PP pipe into the house or building. After welding the PP parts, the T is insulated with an open HDPE T-sleeve and filled with PUR foam.

- For connections with flexible PEX pipes in small dimensions and using the above methods, please contact aquatherm.



Connection of the aquatherm energy pipe to an existing installation

- Metallic piping -

Linear expansion is a significant factor here during installation. The medium pipes made of PP-R/PP-RCT cannot compensate for the linear expansions of steel pipes. In the case of mixed installations with a PP/steel building inlet, a change of direction should be made immediately after the building inlet. If this is not possible, check whether a compensation option can be installed for a straight connection.

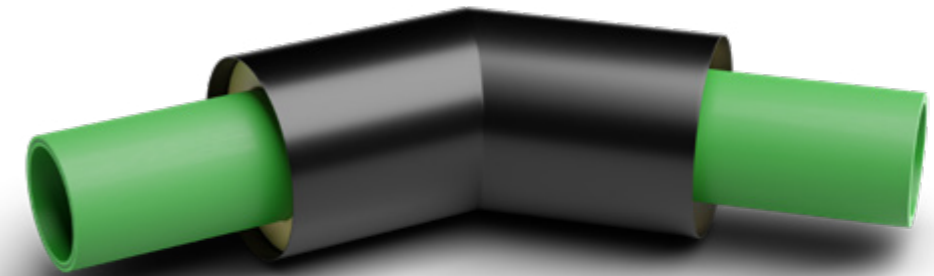

Connecting points ___

Medium pipe connection ___

The medium pipes and fittings are provided with a free pipe end of 250 mm, which is uninsulated in order to be able to make a professional and proper connection.

The joints are produced on site using the socket welding method for the pipe dimensions 32 to 125 mm, and the butt welding method for the pipe dimensions 160 to 355 mm.

aquatherm offers a wide range of insulated joints for connecting pipes, bends, reducers and tees:

- WTD shrink joint with PUR half-shells
- HDPE welding joint with PUR foam
- Monotop 40 insulation tape
- aquatherm black half-shells

See also aquatherm article list.

Insulating tape (water protection tape) MONO Top 40 ___

MONO Top 40 is a strong self-welding insulation tape with a very flexible plastic outer layer. It is used as an alternative for shrink joints or as a repair tape for damaged casing pipes.



aquatherm energy - Socket ___

The aquatherm energy - socket is a cross-linked, self-sealing shrink socket for pre-insulated pipe systems. The sockets are available in WTD design, and also as reducing sockets.



Half-shell PUR - Hard foam ___

For the professional and proper sheathing of joints on pipes and fittings, insulating half-shells made of rigid PUR foam are available for the aquatherm energy pipe systems.



Dimension change

The following articles can be used to change the dimension:

Reducing-energy joints consisting of shrink sleeve with PUR rigid foam elements, dimension-dependent moulded part and accessories in a total length of 900 mm.

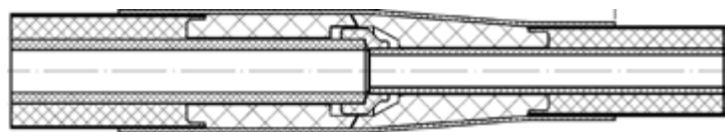

aquatherm energy blue/green

Pre-insulated fibre composite piping systems for underground supply networks

The transport of district heating energy over long distances requires a complex, mostly buried pipe system. High demands are made on the carrier pipe as well as on the pipe insulation.

aquatherm offers a factory insulated aquatherm energy blue fibre composite pipes. The ideal district heating pipes for heating networks, which are operated with operating pressures up to 20 bar and operating temperatures up to 90 °C.

The insulated aquatherm blue composite pipes can also be used as cooling and refrigerant pipes. The pipe is insulated at the factory with PUR rigid foam, which completely surrounds the service pipe. To protect the insulation layer against mechanical or weather-related influences on the outside, the outer casing consists of a PEHD protective pipe.

Fittings such as elbows, bends or T-pieces are insulated in the same way at the factory. The joints between the pipe and the fitting are made on site in the pipe dimensions 32 to 125 mm using the socket welding method, and in the dimensions 160 to 355 mm using the butt welding method.

These joints are insulated with post-insulation sleeves, which enable continuous insulation of the district heating pipe.

aquatherm energy blue/green pipes are offered in lengths of 5.8m and 11.6m. We offer fittings with leg lengths of 0.5m and 1.0m.

The pipe system is optionally available with trace heating and mains monitoring. Special designs available on request.

Medium pipes

aquatherm energy blue/green Fibre composite pipe system for heating, cooling and waste water
 SDR 9 in the dimension 32 mm
 SDR 11 in the dimensions 40 – 355 mm and
 SDR 17,6 in the dimensions 125 – 355 mm

aquatherm energy blue OT Diffusion-tight fibre composite piping system for heating and industrial water
 SDR 9 in the dimension 32 mm
 SDR 11 in the dimensions 40 – 250 mm

		Potable water	Building services	Swimming pool technology	Chemicals	District heating	Geothermal	Refrigeration & Air Conditioning
SDR 9	MF RP	●	○	○	●	○	○	○
SDR 9	MF RP	·	●	●	●	●	●	●
SDR 9	MFRPOT	·	●	●	●	●	●	●
SDR 11	MF RP	·	●	●	●	●	●	●
SDR 11	MFRPOT	·	●	●	●	●	●	●
SDR 17,6	MF RP	·	●	●	●	●	●	●

- Recommended system due to the technical advantages
- Use of the system is possible

System features aquatherm energy

- Pressure loss
- Flow velocity
- Heat and cold loss

aquatherm energy – Materials - Technical data

The materials used at aquatherm energy are characterised by the following mechanical and thermal properties.

aquatherm energy blue/green

Low linear expansion	○
Corrosion resistant	○
Very good welding properties	○
Low pipe roughness	○
High impact strength	○
Heat stabilised	○
Recyclable	○
Sound and heat insulating	○
Low weight	○
Self-compensating	○

Flow velocity limitations are necessary with metal pipes to prevent erosion. Due to the natural noise attenuation of aquatherm pipes and the natural ability of the pipe to absorb the forces of water hammer, as well as the full internal diameter of the fittings, we can significantly increase the flow velocities in the pipe compared to comparable steel pipes without compromising the pipe's ability to prevent noise and water hammer.

aquatherm has published tables with pressure losses and flow velocities of up to 4.6 m/s, which is far above the values that any metallic pipe system can offer.

This often opens up the possibility of reducing the pipe dimension.

Also for heat and cold loss calculations for your piping network, our experts are at your disposal with calculation support tools. Furthermore, aquatherm also offers all common CAD models for download for your digital planning.

[CAD-Model planning](#)

We are happy to support you in planning your project - for example, with our digital planning aids.

[Digital planning aid](#)

Technical data	PUR
Compressive strength 10 % deformation	> 0,3 N/mm ²
Closed cell	> 88 %
Core density	> 60 kg/m ³
Shear strength	> 0,12 N/mm ²
Tangential shear strength	> 0,20 N/mm ²
Water absorption	< 10 % (Vol)
Thermal conductivity at 50 °C	0,027 W/mK
Cell gas cyclopentane	> 8 %

Material properties	HDPE 80
Technical data	HDPE 80
Ddensity, g/cm ³ , ISO 1183	0,950
Yield stress, MPa, DIN EN ISO 527	22
Elongation at yield stress, %, DIN EN ISO 527	9
Elongation at break, %, DIN EN ISO 527	300
Zug-E-Modul, MPa, DIN EN ISO 527	800
Impact strength, kJ/m ² ,DIN EN ISO 179	Without fracture
Notched impact strength, kJ/m ² , DIN EN ISO 179	12
Ball indentation hardness, MPa, DIN EN ISO 2039-1	40
Shore hardness, D, ISO 868	63
Mean thermal expansion coefficient, K-1, DIN 53752	1,8 · 10 ⁻⁴
Thermal conductivity, W/m · K, DIN 52612	0,38
Dielectric strength, kV/mm, VDE 0303-21	47
Surface resistance, Ohm, DIN IEC 167	10 ¹⁴
Flammability, DIN 4102	B2
Physiological harmlessness according to BgVV	yes
Chemical resistance according to DIN 8075 supplementary sheet	fulfils
Temperature application range, °C	- 40 bis + 80

Technical data	PP-MF
Melt index 230°C/2,16 kg	0,3g / 10 min
Density	1,0 g / cm ³
Modulus of elasticity	1200 N/ mm ²
Yield stress	30 N / mm ²
Tensile strength	35 MPa
Thermal conductivity coefficient	0,15 W / mK
Pipe roughness	0,007 mm
Average therm. Linear exp. -Coeff.	0,035 mm / mK



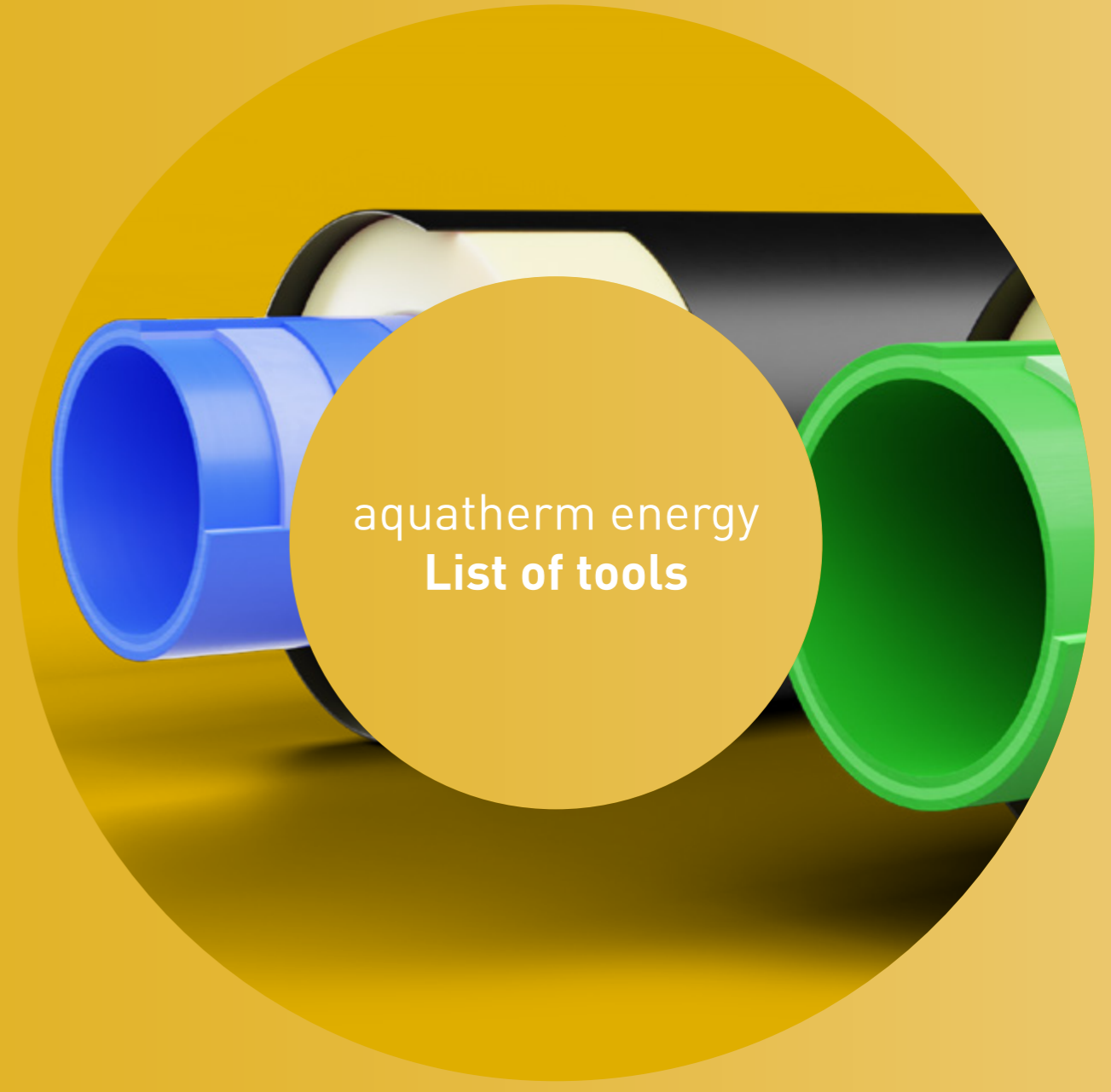

aquatherm energy
List of tools

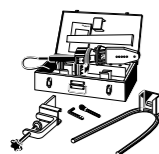

aquatherm manual welding device 800 W

Article no.	Dimension [mm]	PU	RG
9800050337	for pipes Ø 16-63 mm	1	3

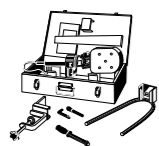

aquatherm manual welding device 1400 W

Article no.	Dimension [mm]	PU	RG
9800050341	for pipes Ø 50-125 mm	1	3

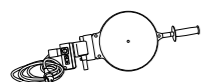

Manual welding device 1500 W

Article no.	Dimension [mm]	PU	RG
9800050330	for pipes Ø 50 - 160 mm	1	3

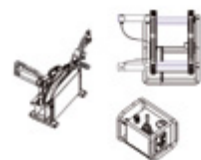

aquatherm butt welding machine-two-ring-machine Widos

Article no.	Dimension [mm]	Weight [kg]	PU	RG
9800050350	Ø 160 - 250 mm	154,000	1	3
9800050351	Ø 160 - 315 mm	178,000	1	3

The butt-welding-two-ring machine can be purchased directly from Widos (www.widos.de)
Two-ring machine for pipes 160 - 355 mm available on request



aquatherm butt welding machine Widos

Article no.	Dimension [mm]	Weight [kg]	PU	RG
9800050352	for pipes Ø 160-250 mm	195,000	1	3
9800050353	for pipes Ø 160-315 mm	250,000	1	3
9800050355	for pipes Ø 200-450 mm	430,000	1	3
9800050356 **	for pipes Ø 200-500 mm	500,000	1	3
9800050357 **	for pipes Ø 315-630 mm	885,000	1	3

The butt-welding-machine can be purchased directly from Widos (www.widos.de)
*special voltage on demand

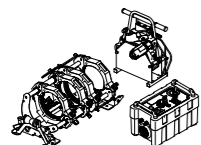

aquatherm butt welding machine Ritmo

Article no.	Dimension [mm]	Weight [kg]	PU	RG
9800050165	for pipes Ø 160 - 250 mm	176,500	1	3
9800050166	for pipes Ø 160 - 315 mm	160,000	1	3
9800050169	for pipes Ø 400 - 630 mm	710,000	1	3

*Also available: 110 V (for Ø 160 - 250 mm or Ø 160 - 315 mm)
including wooden transport box. The butt welding machine can be obtained directly from Ritmo (www.ritmo.it)
Two-ring machine for pipes 160 - 355 mm available on request

aquatherm welding tools

Article no.	Dimension [mm]	PU	RG
9800050206	16	1	3
9800050208	20	1	3
9800050210	25	1	3
9800050212	32	1	3
9800050214	40	1	3
9800050216	50	1	3
9800050218	63	1	3
9800050220	75	1	3
9800050222	90	1	3
9800050224	110	1	3
9800050226	125	1	3

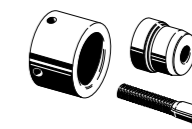

aquatherm surface thermometer

Article no.	PU	RG
9800050188	1	3

to check the correct welding temperature



aquatherm temperature pencil

Article no.	PU	RG
9800050190	1	3

to check the correct welding temperature

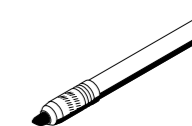

aquatherm electric welding jig

Article no.	Dimension [mm]	Weight [kg]	PU	RG
9800050161	for pipes Ø 63 - 125 mm	24,000	1	3

incl. spare battery, charging station and metal case

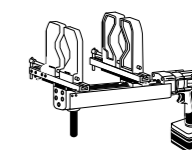

aquatherm base for art. no. 9800050161

Article no.	PU	RG
9800050151	1	3

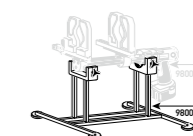

Legend Table abbreviations (Units in mm unless otherwise stated)

d	Diameter in mm	l/m	Water content in litres per metre	RG	Discount group
D	Diameter in mm	kg/m	Weight in kg per metre	SDR	Standard Dimension Ratio (Diameter/wall thickness ratio)
s	Wall thickness in mm	DN	Nominal diameter		
di	Clear span in mm	PU	Packing unit		



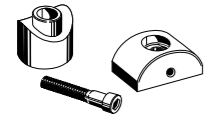

aquatherm saddle welding tools

for welding saddles

Article no.	Dimension [mm]	PU	RG
9800050614	40 x 20/25	1	3
9800050616	50 x 20/25	1	3
9800050619	63 x 20/25	1	3
9800050620	63 x 32	1	3
9800050623	75 x 20/25	1	3
9800050624	75 x 32	1	3
9800050625	75 x 40	1	3
9800050627	90 x 20/25	1	3
9800050628	90 x 32	1	3
9800050629	90 x 40	1	3
9800050631	110 x 20/25	1	3
9800050632	110 x 32	1	3
9800050634	110 x 40	1	3
9800050635	110 x 50	1	3
9800050636	125 x 20/25	1	3
9800050638	125 x 32	1	3
9800050640	125 x 40	1	3
9800050642	125 x 50	1	3
9800050644	125 x 63	1	3
9800050648	160 x 20/25	1	3
9800050650	160 x 32	1	3
9800050652	160 x 40	1	3
9800050654	160 x 50	1	3
9800050656	160 x 63	1	3
9800050657	160 x 75	1	3
9800050658	160 x 90	1	3
9800050660	200 x 20/25	1	3
9800050662	200 x 32	1	3
9800050664	200 x 40	1	3
9800050666	200 x 50	1	3
9800050667	200 x 75	1	3
9800050668	200 x 63	1	3
9800050669	200 x 90	1	3
9800050670	200 x 110	1	3
9800050671	200 x 125	1	3
9800050672	250 x 20/25	1	3
9800050674	250 x 32	1	3
9800050676	250 x 40	1	3
9800050678	250 x 50	1	3
9800050680	250 x 63	1	3
9800050682	250 x 75	1	3
9800050684	250 x 90	1	3
9800050686	250 x 110	1	3
9800050688	250 x 125	1	3

aquatherm saddle welding tools

(continued) for welding saddles

Article no.	Dimension [mm]	PU	RG
9800050690	315 x 63	1	3
9800050692	315 x 75	1	3
9800050694	315 x 90	1	3
9800050696	315 x 110	1	3
9800050698	315 x 125	1	3
9800050699	315 x 160	1	3
9800050712	355 x 63	1	3
9800050714	355 x 75	1	3
9800050716	355 x 90	1	3
9800050718	355 x 110	1	3
9800050720	355 x 125	1	3
9800050722	355 x 160	1	3
9800050726	400 - 630 x 63	1	3
9800050728	400 - 500 x 75	1	3
9800050730	560 - 630 x 75	1	3
9800050732	400 - 500 x 90	1	3
9800050734	560 - 630 x 90	1	3
9800050736	400 - 450 x 110	1	3
9800050738	500 - 560 x 110	1	3
9800050740	630 x 110	1	3
9800050742	400 x 125	1	3
9800050744	450 - 500 x 125	1	3
9800050746	630 x 125	1	3

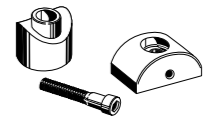

aquatherm repair set

Article no.	Dimension [mm]	PU	RG
9800050307	7	1	3
9800050311	11	1	3

to close holes of up to 10 mm in the pipe



aquatherm pipe repair stick

Article no.	Dimension [mm]	PU	RG
1090000035	7/11 mm	10	1
3090000012	7/11 mm	10	42

for pipe repairs



aquatherm thermometer glove

Article no.	PU	RG
9800050195	2	3

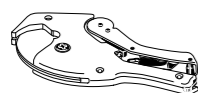

aquatherm pipe cutter

Article no.	Dimension [mm]	PU	RG
9800050102	for pipes Ø 16 - 40 mm	1	3
9800050105	for pipes Ø 50 - 125 mm	1	3
9800050106	for pipes Ø 63 - 200 mm	1	3

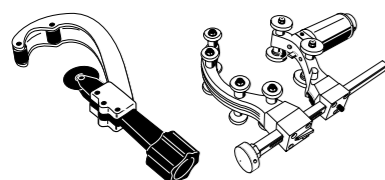

aquatherm pipe cutter

Article no.	Dimension [mm]	PU	RG
9800050103	for pipes up to 25 mm	1	3
9800050104	for pipes Ø 16 - 40 mm	1	3

aquatherm energy primer

Article no.	Quantity	PU	RG
9702411002	Energy can 1l	1	10

aquatherm cleaning wipes

Article no.	Quantity	PU	RG
9800050193	can with 100 cleaning wipes	1	3

for electrofusion sockets

aquatherm energy warning tape

Colour: yellow / printing in black: "Attention district heating pipeline"

Article no.	Description	PU	RG
9700050191	warning tape	1	10

aquatherm energy mono top 40 insulation tape

for post-insulation of connections with the aquatherm insulation-socket set

Article no.	length	PU	RG
9702411000	energy width 50 mm length 15m	1	10
9702411001	energy width 100 mm length 15m	1	10

aquatherm energy compact seals

Pipe collar for wall duct

Article no.	Ø core drill hole	Ø outside medium piped	Ø outside casing pipe	PU	RG
9701214212	150	32	90	1	10
9701214214	200	50	110	1	10
9701214218	200	63	125	1	10
9701214220	200	75	140	1	10
9701214222	250	90	160	1	10
9701214224	300	110	200	1	10
9701214226	350	125	225	1	10
9701214230	350	160	250	1	10
9701214234	400	200	315	1	10
9701214238	500	250	400	1	10
9701214242	550	315	450	1	10

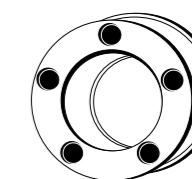

aquatherm energy closing collar

Collar for closing the PUR-insulating layer from casing pipe to medium

Article no.	Quantity	PU	RG
2390032001	Closing collar 32 mm MR90	1	10
2390050002	Closing collar 40-50 mm MR110	1	10
2390075003	Closing collar 63-75 mm MR125-140	1	10
2390090004	Closing collar 90 mm MR160	1	10
2390110005	Closing collar 110 mm MR200	1	10
2390125006	Closing collar 125 mm MR225	1	10
2390160007	Closing collar 160 mm MR250	1	10
2390200008	Closing collar 200 mm MR315	1	10
2390250009	Closing collar 250 mm MR400	1	10
2390315010	Closing collar 315/355 mm MR450/500	1	10



aquatherm cutting disc for plastic

Article no.	Dimension [mm]	PU	RG
9800050107	for pipes Ø 125 mm	1	3
9800050109	for pipes Ø 230 mm	1	3

Application: for each angle grinder. Design: diamant galvanised cutting disc

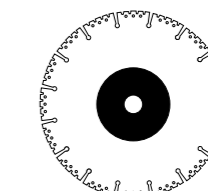

aquatherm chamfering tool for aquatherm blue OT and UV-Pipes

chamfering tool for Ø 32 - 250mm

Article no.	PU	RG
9800050510	1	3

For removing the OT-layer before the butt-welding process and for breaking the edges of the blue for processing the push-fit adapter and push-fit coupling.





aquatherm universal peeling tools

for aquatherm green MF UV, aquatherm green MF RP UV, aquatherm blue MF RP UV and aquatherm blue MF OT

Article no.	Dimension [mm]	PU	RG
9800050479	20	1	3
9800050480	25	1	3
9800050481	32	1	3
9800050482	40	1	3
9800050483	50	1	3
9800050484	63	1	3
9800050485	75	1	3
9800050486	90	1	3
9800050487	110	1	3
9800050488	125	1	3
9800050501	Spare blade with screw (Set)	1	3

Required for the socket welding

(in combination with socket welding fittings from page 23 onwards, e.g. sockets, elbows, T-pieces, transition pieces with thread) Also suitable for manual peeling (bolts included).

Not suitable for aquatherm green S, aquatherm blue S, aquatherm green MF, aquatherm green MF RP, aquatherm energy green, aquatherm blue energy RP

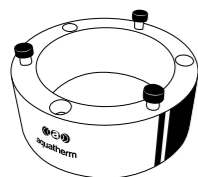

aquatherm extension for universal peeling tool

Article no.	Dimension [mm]	PU	RG
9800050489	for peeling tool 20 mm Art. no. 9800050479	1	3
9800050490	for peeling tool 25 mm Art. no. 9800050480	1	3
9800050491	for peeling tool 32 mm Art. no. 9800050481	1	3
9800050492	for peeling tool 40 mm Art. no. 9800050482	1	3
9800050493	for peeling tool 50 mm Art. no. 9800050483	1	3
9800050494	for peeling tool 63 mm Art. no. 9800050484	1	3
9800050495	for peeling tool 75 mm Art. no. 9800050485	1	3
9800050496	for peeling tool 90 mm Art. no. 9800050486	1	3
9800050497	for peeling tool 110 mm Art. no. 9800050487	1	3
9800050498	for peeling tool 125 mm Art. no. 9800050488	1	3

Required for electrofusion socket welding. When electrofusion welding a longer welding depth is required, which is achieved by the combination of the universal peeling tool and the extension for the universal peeling tool (e.g. Art. no. 9800050479 + 9800050489)

aquatherm universal peeling tool-set 20 – 63 mm

Article no.	Dimension [mm]	PU	RG
9800050477	for pipes Ø 20 - 63 mm	1	3

consisting of:

- 1x case
- 1x peeling tool 20 – 63 mm
- 1x attachment plate for universal peeling tool 980005079–9800050484
- 1x toggle-set
- 1x torx wrench
- 1x hexagon Allen key size 4
- 6x fixing screws 9800050489–9800050494 M5x25

aquatherm universal peeling tool-set 75 – 125 mm

Article no.	Dimension [mm]	PU	RG
9800050478	for pipes Ø 75 x - 125 mm	1	3

consisting of:

- 1x case
- 1x peeling tool 75 – 125 mm
- 1x attachment plate for universal peeling tool 9800050485–9800050488
- 1x toggle-set
- 1x torx wrench
- 1x hexagon Allen key size 4
- 6x fixing screws for Art. no. 9800050495–98000498 M5x35

aquatherm attachment plate for universal peeling tool

Article no.	Dimension [mm]	PU	RG
9800050499	for peeling tools 9800050479–9800050484	1	3
9800050500	for peeling tools 9800050485–9800050488	1	3

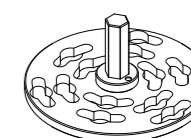

aquatherm peeling tools for electrofusion socket welding

for aquatherm green S, aquatherm green MF, aquatherm green MF RP, aquatherm energy green MF, aquatherm blue S RP, aquatherm blue MF RP and aquatherm energy blue MF RP

Article no.	Dimension [mm]	PU	RG
In combination with a drilling machine			
9800050558	20 mm not for OT MS	1	3
9800050560	25 mm not for OT MS	1	3
9800050562	32 mm not for OT MS	1	3
9800050564	40 mm not for OT MS	1	3
9800050566	50 mm not for OT MS	1	3
9800050568	63 mm not for OT MS	1	3
9800050570	75 mm not for OT MS	1	3
9800050572	90 mm not for OT MS	1	3
9800050440	Art.9800050506 - 9800050572/9800050910-9800050914	1	3
for manual peeling			
9800050574	110 mm not for OT MS	1	3
9800050576	125 mm not for OT MS	1	3
9800050580	160 mm not for OT MS	1	3
9800050441	Art.9800050506 - 9800050572/9800050910-9800050914	1	3

9800050592	200 & 250 mm not for OT MS	1	3
9700099739	spare blade	1	3

Not suitable for aquatherm green UV, aquatherm green MF RP UV, aquatherm blue MF RP UV and aquatherm blue MF RP OT

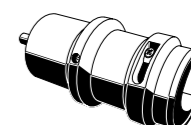

Article no. 9800050558 – 9800050572 in combination with drill

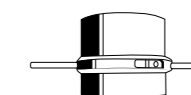

Article no. 9800050574 – 9800050580

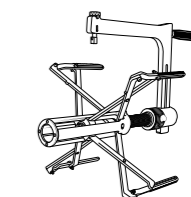

Article no. 9800050592

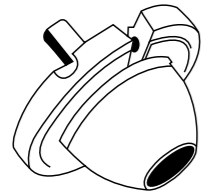

aquatherm saddle peeling tools for OT and UV pipes Ø 50–125 mm

Article no.	Dimension [mm]	PU	RG
9800050921	for welding saddles Ø 20 & 25 mm	1	3
9800050922	for welding saddles Ø 32 mm	1	3
9800050924	for welding saddles Ø 40 mm	1	3
9800050926	for welding saddles Ø 50 mm	1	3
9800050928	for welding saddles Ø 63 mm	1	3

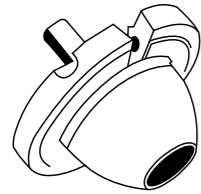

aquatherm saddle peeling tools for OT and UV pipes 160–250 mm

Article no.	Dimension [mm]	PU	RG
9800050421	for welding saddles Ø 20 & 25 mm	1	3
9800050422	for welding saddles Ø 32 mm	1	3
9800050424	for welding saddles Ø 40 mm	1	3
9800050426	for welding saddles Ø 50 mm	1	3
9800050428	for welding saddles Ø 63 mm	1	3

aquatherm drills

for installation of weld-in saddles



Article no.	Dimension [mm]	PU	RG
9800050940	20 & 25 (40-160 mm)	1	3
9800050941	20 & 25 (63-250 mm)	1	3
9800050942	32	1	3
9800050944	40	1	3
9800050946	50	1	3
9800050948	63	1	3

*may only be used in fixed drilling machines

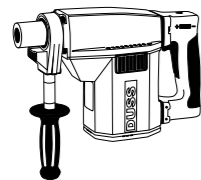

aquatherm drill DUSS DIA 303

Article no.	PU	RG
9800050978	1	3

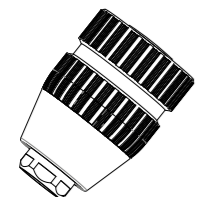

aquatherm keyless chuck clamping range 1,5 – 13 mm

Article no.	PU	RG
9800050971	1	3

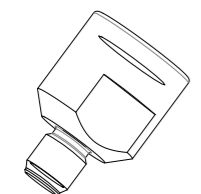

aquatherm chuck adapter for art. no. 9800050971

Article no.	PU	RG
9800050969	1	3

Saddle-hole saw for branch

Article no.	Dimension [mm]	Required items	PU	RG
9800050987	75	9800050973	1	3
9800050988	90	9800050973	1	3
9800050989	110	9800050975 & 9800050976	1	3
9800050990	125	9800050975 & 9800050976	1	3
9800050991	160	9800050975 & 9800050976	1	3

for assembly of weld-in saddles

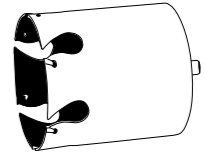

aquatherm drill rig for duss-drill

Article no.	PU	RG
9800050977	1	3

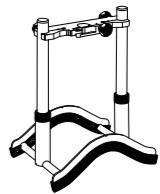

aquatherm welding fixture for drill rig 50977

Article no.	PU	RG
9800050979	1	3

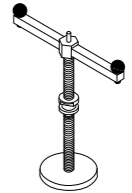

aquatherm quick change adapter 75 – 90mm

Article no.	PU	RG	
9800050973	for Art. no. 9800050987 & 9800050988	1	3

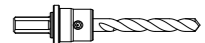

aquatherm center drill LSZ 1

Article no.	PU	RG	
9800050975	for Art. no. 9800050989 - 9800050991	1	3



aquatherm hole saw holder LSA3

Article no.	Dimension [mm]	PU	RG
9800050976	1/2" for drill chuck 13 mm	1	3

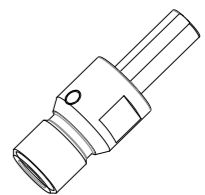

aquatherm hole saw holder LSA2

Article no.	Dimension [mm]	PU	RG
9800050974	1/2" for DUSS-machines	1	3

